

TECHNICAL SPECIFICATIONS5 OUTPUT MODULE

5 Output module is a fuse module with five fully fused outputs. When ordering, check that the card fits the battery backup the card is to be installed in.

MOUNTING IN BATTERY BACKUP

The card is delivered mounted in it's plastic casing, for easy installation.

If the card has come loose, snap it back into the plastic casing.

Mount the card on any card slot in the enclosure, leave space for cables.



Important

Install the board before screwing on wiring or commissioning.

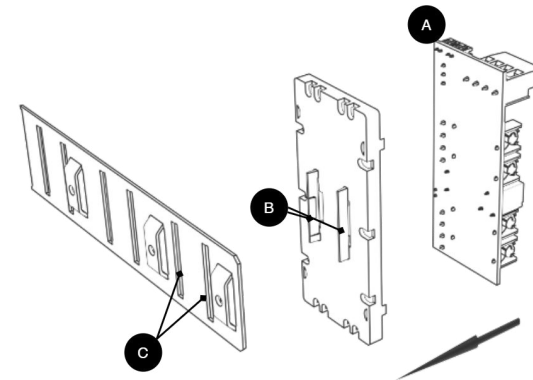
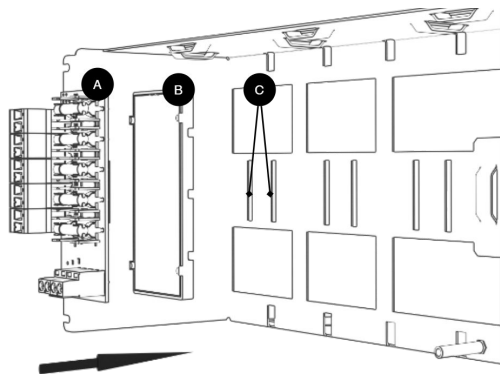

Letter	Explanation	Comment
A	Optional card	Optional card comes mounted on plastic housing from factory. Has it come loose? Snap it back on before mounting the card.
B	Plastic casing	The plastic casing has hooks for attaching slots in the plate.
C	Place for plastic casing	Slits in sheet metal to snap the plastic bracket.

CARD DESCRIPTION 5 OUTPUT MODULE

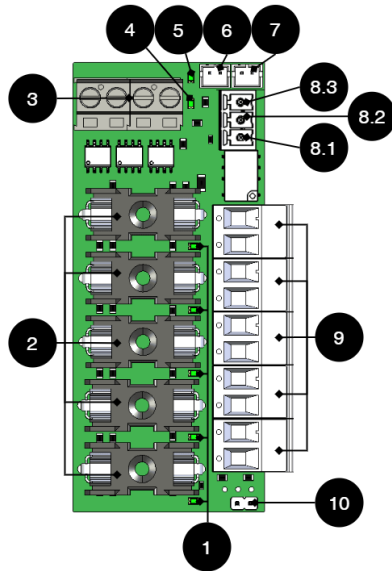

Circuit Board Overview - 5 Output module

Nr	On circuit boards	Explanation
1	D1-D4	Green indicator LED, illuminates with a solid green light when the fuse is ok.

Nr	On circuit boards	Explanation
2	F1-F5	Fuses
3	J22, J23	Incoming voltage from motherboard, 24 V.
4	D29	Red indicator LED, illuminates with a solid green light when a fuse is broken.
5	D30	Green indicator LED, illuminates with a solid green light when the fuse is ok.
6	J6	Connection to alarm on motherboard.
7	J7	Bridging connection for alarms from another card.
8.1	P3: 1-3	Alarm output, NC.
8.2	P3:2	Alarm output, Com,
8.3	P3:3	Alarm output, NO,
9	P2: 1-10	Load output +/-
10	JU4	Jumper for setting the voltage in the card. Unbuilt = 24 V (factory setting). Built = 12 V. * * The card must have the same voltage as the motherboard.

Use the supplied cable

Use the cable that comes with the box to connect the card.

CONNECT 5 OUTPUT MODULE FOR MOTHERBOARD: CEO3 V2.1

Connect the card as shown in the illustration.

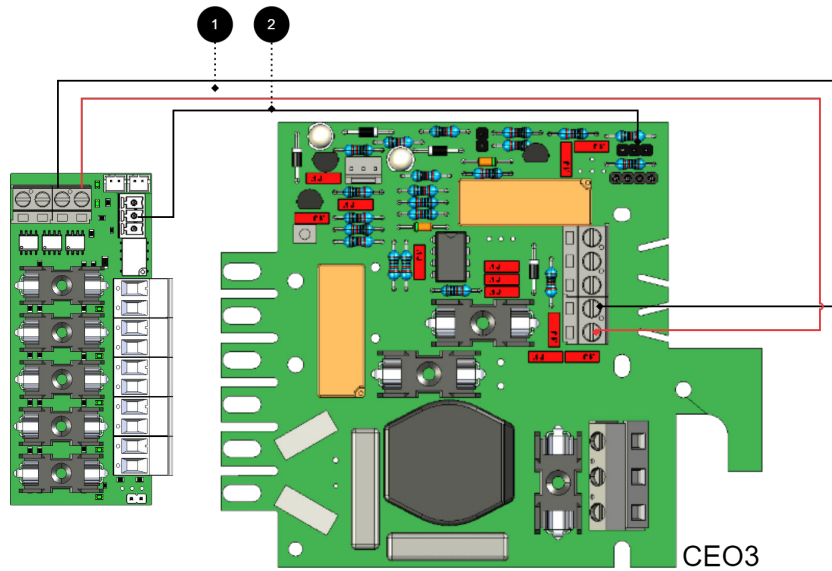

+ and - from load on motherboard is connected to + and - on the option card.

Communication is connected between terminals as the solid line shows.

Connections from battery backup to security card

Nr	Couplings	5 Output module	Motherboard
1	Power supply connection:	IN 12 V / 24 V	Load output 1
2	Alarm output: switched between NO and Com.	J6	JU3 - connect middle pin and one outer pin.

CONNECT 5 OUTPUT MODULE FOR MOTHERBOARD: CEO3 V5

Connect the card as shown in the illustration.

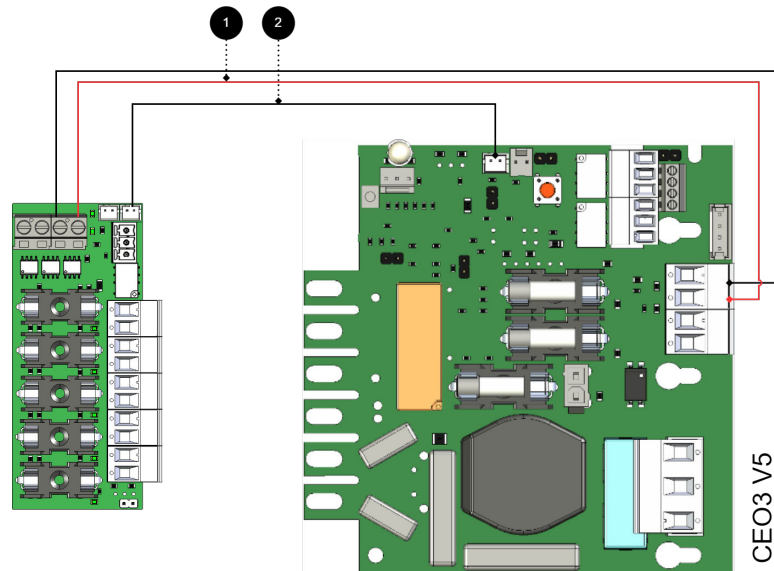

+ and - from load on motherboard is connected to + and - on the option card.

Communication is connected between terminals as the solid line shows.

Connections from battery backup to security card

Nr	Couplings	5 Output module	Motherboard
1	Power supply connection:	IN 12 V / 24 V	Load output 1
2	Connection to alarm on motherboard or	J6	J27
	bridging of alarm to another 5 Output module	J7	-

CONNECT 5 OUTPUT MODULE FOR MOTHERBOARD: NEO3

Connect the card as shown in the illustration.

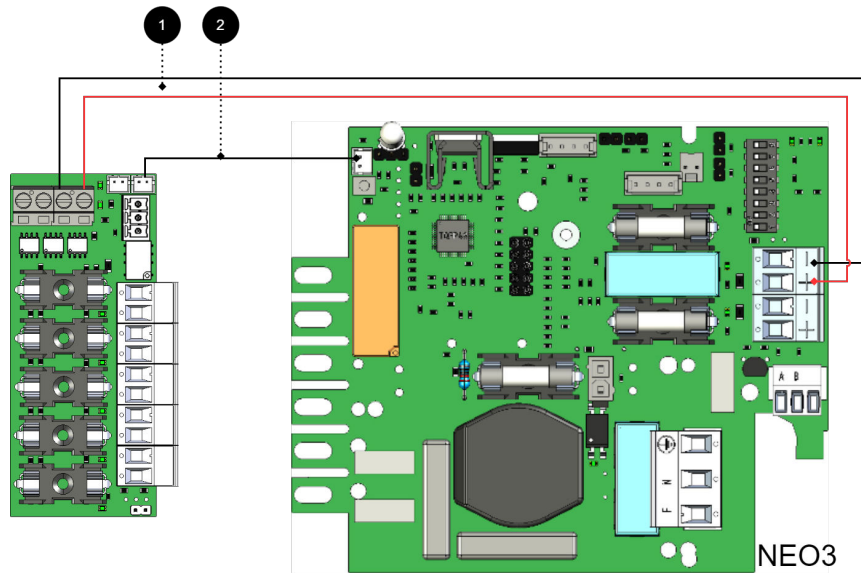

+ and - from load on motherboard is connected to + and - on the option card.

Communication is connected between terminals as the solid line shows.

Connections from battery backup to security card

Nr	Couplings	5 Output module	Motherboard
1	Power supply connection:	IN 12 V / 24 V	Load output 1
2	Connection to alarm on motherboard: bridging of alarms to / from additional option cards	J6 J7	J5 -

CONNECT 5 OUTPUT MODULE FOR MOTHERBOARDS: PRO1 5 A AND 10 A

Connect the card as shown in the illustration.

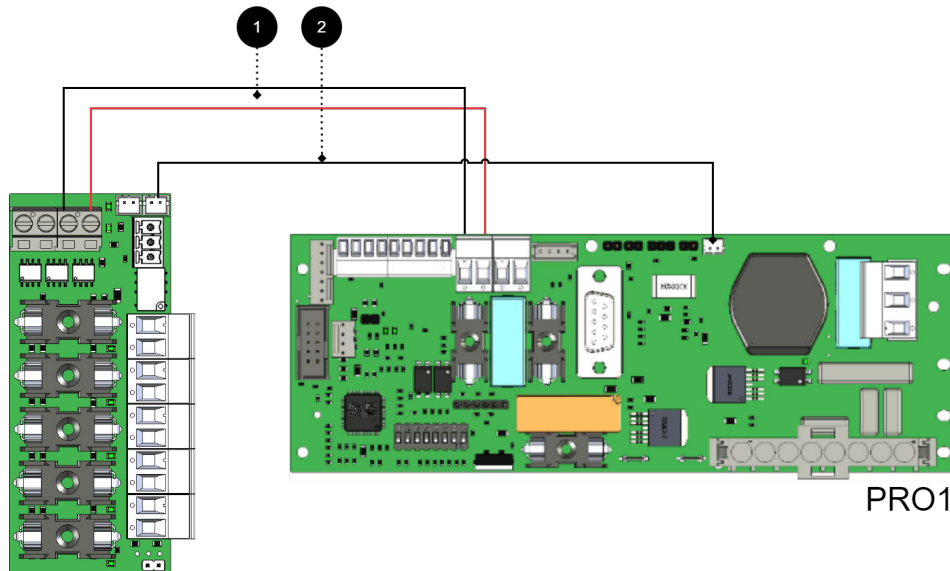

+ and - from load on motherboard is connected to + and - on the option card.

Communication is connected between terminals as the solid line shows.

Connections from battery backup to security card

Nr	Couplings	5 Output module	Motherboard
1	Power supply connection:	IN 12 V / 24 V	Load output 1
2	bridging of alarms for motherboards:	J7	J13
	bridging of alarms from / to additional option cards	J6	-

CONNECT 5 OUTPUT MODULE FOR MOTHERBOARD: PRO2 V3 15 A AND 25 A

Connect the card as shown in the illustration.

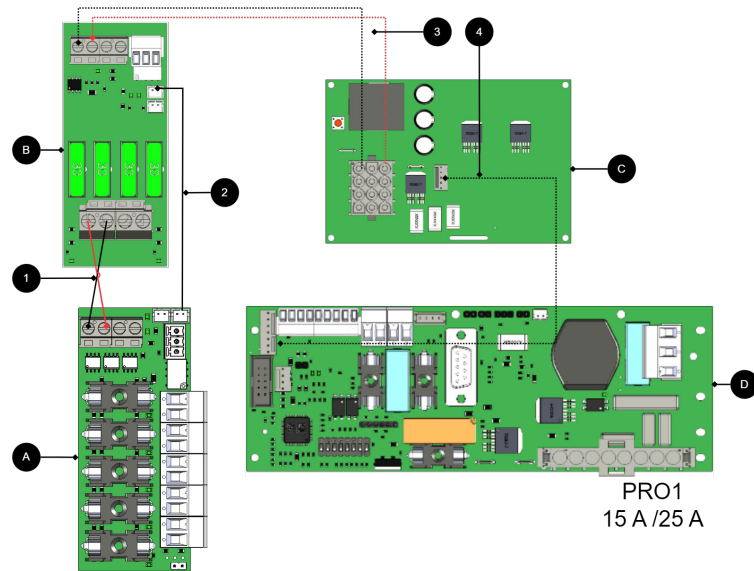

Connections 15 A and 25 A units

No. / letter	On circuit boards	Explanation
A	5 Output module	Option card (A).
B	2 Output module	Connect power supply (24 V) to 5 Output module (A).
C	Power card	Available in 15 A and 25 A units.
D	PRO1	Motherboard
1	IN 24 V	Connect power supply from 2 output module (B).
2	J7	Connect alarm to load card.
3, 4	-	Internal power supply and communication between cards.

CONNECT 5 OUTPUT MODULE FOR MOTHERBOARD: PRO2 V3 15 A AND 25 A

Connect the card as shown in the illustration.

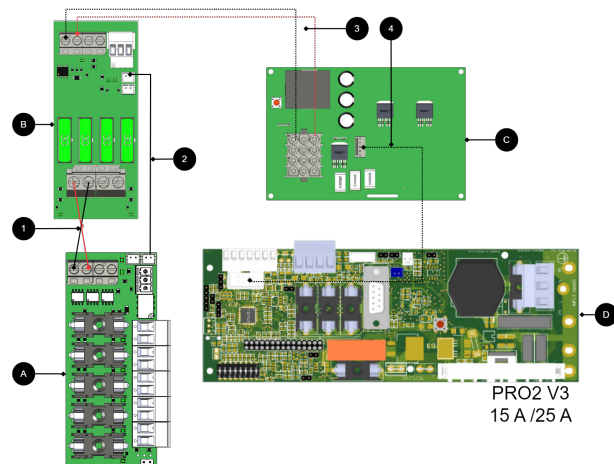

Connections 15 A and 25 A units

No. / letter	circuit board	Explanation
C	Power card	Available only on 15 A and 25 A units.
D	Motherboard	PRO2 v3
2	J7	Connect alarm to load card.
1	IN 24 V	Connect power supply from 2 output modules.
A	5 Output module	Option card.
B	2 Output module	Connect power supply (24 V) to 5 Output module.
3, 4	-	Internal power supply and communication between cards.

CONNECT 5 OUTPUT MODULE FOR MOTHERBOARD: PRO3

Connect the card as shown in the illustration.

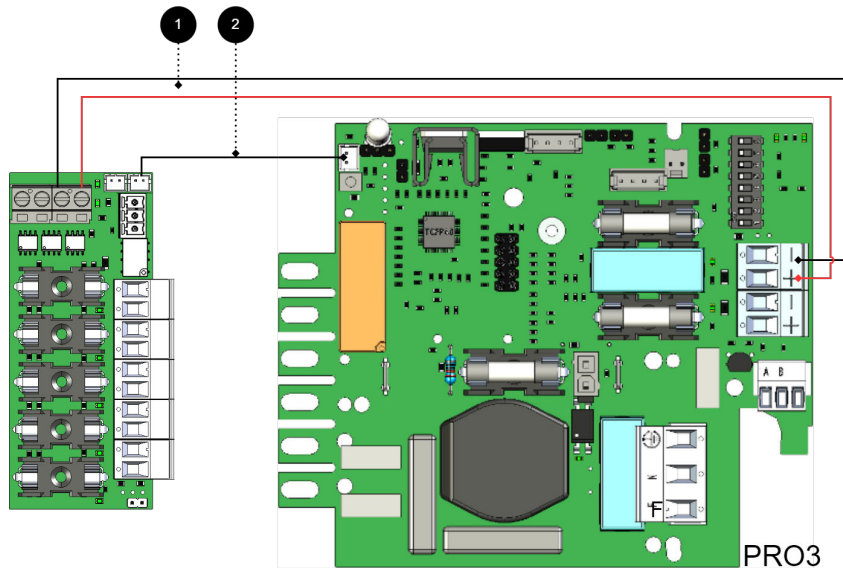

+ and - from load on motherboard is connected to + and - on the option card.

Communication is connected between terminals as the solid line shows.

Connections from battery backup to security card

Nr	Couplings	5 Output module	Motherboard
1	Power supply connection:	IN 12 V / 24 V	Load output 1
2	Connection to alarm on motherboard: bridging of alarms to / from additional option cards.	J7 J6	J5 -

IF THE CARD LACKS A WHITE (JST) CONTACT OR IF THE ALARM IS TO BE GIVEN VIA RELAY SWITCHING

Connect the card as shown in the picture.

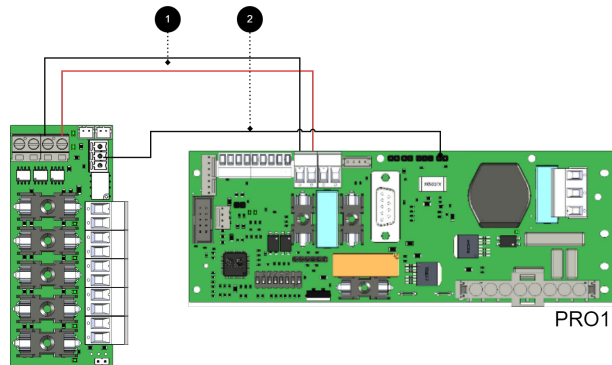

+ and - from load on motherboard are connected to + and - on the option board.

Communication is connected between terminals as the solid line shows.

Connections from battery backup to fuse board

No	Connections	5 Output module	Motherboard
1	Power supply connection:	IN 12 V / 24 V	Load output 1
3	Alarm output:	P3:1-2	J15

CONNECTION OF ADDITIONAL 5 OUTPUT MODULE

Connection of additional option cards to motherboards

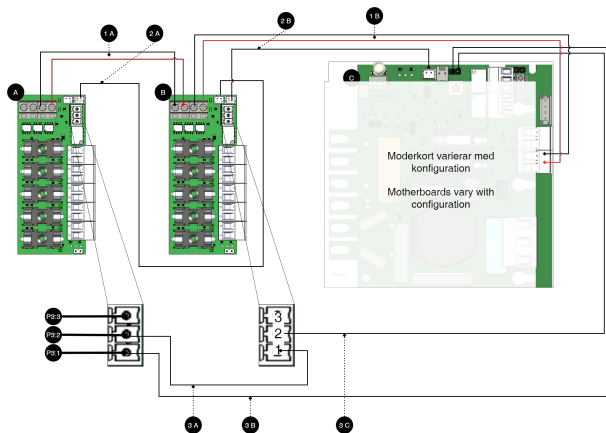

Note

For alarm connection use 2A and 2B for connection of newer devices (after approx. 2018). For older devices (before approx. 2018) use 3A-3C.

Connection of additional option cards

Letter / No.	Explanation	On the card
A	5 Output module.	-
B	5 Output module.	-
C	Motherboard, varies with configuration.	-
1 A	Power supply from 1B.	IN 24 V
1 B	Power supply from C (motherboard).	IN 24 V
2 A	Bridging of alarm to card B.	J7
2 B	Connection of alarm on C (motherboard) from card A	See table below.
3 A	Jumper between cards A and B.	P3: 1-3
3 B	Alarm output switches on C (motherboard).	P3: 1-3
3 C	Alarm output is connected to C (motherboard).	P3: 1-3

P3	Explanation
P3:1	NC
P3:2	Com
P3:3	NO

Alarms from optional cards are connected on terminal block (on motherboard)

Motherboard	Terminal as an alarm from an optional card must be connected (on motherboard)
CEO3 v5	J27

Motherboard	Terminal as an alarm from an optional card must be connected (on motherboard)
NEO3	J5
PRO1	J13
PRO2 v3	J1
PRO3	J5

TECHNICAL DATA - 5 OUTPUT MODULE

Info	Explanation
Short name:	5 Output module
Product description	5 Output module is a fuse module with five fully fused outputs.
The product fits in	Battery backups with motherboards: PRO1, PRO2, PRO2 V3, PRO3 and NEO3.
Measure	85 x 37 mm
Own consumption	35 mA
Tension	12 V or 24 V
Fuses	On load outputs.
Indication	Yes, LED on circuit board

Outputs

Info	Explanation
Alarm outputs, number	1
Alarm on alternating relay? (Yes No)	Yes, sum alarm in case of fuse fault
Alarm output protocol (communication protocol)	-

Info	Explanation
Load outputs, number	5
Voltage at load output	27.3 V DC
Voltage limit, upper, on load output	27.9 V DC
Voltage limit, lower, on load output. For battery operation and disconnected mains voltage.	20 V DC
Priority (always voltage) load outputs (Yes / No)	Yes
Maximum load, per output	10 A
Maximum load, total, (must not be exceeded).	16 A
Load output plus (+) secured? (Yes No)	Yes
Load output minus (-) secured? (Yes / No)	No
Connection to buzzer? (Yes No)	No

Manufactured in Milleteknik's factory in Partille, Sweden.

This translation is not verified and should be cross referenced with the swedish original before use.

ABOUT TRANSLATION OF THIS DOCUMENT

User manual and other documents are in the original language in Swedish. Other languages are machine translated and not reviewed, errors may occur.

ADDRESS AND CONTACT DETAILS

Milleteknik AB
Ögärdesvägen 8 B
S-433 30 Partille

Sweden
+46 31 340 02 30
info@milleteknik.se

www.milleteknik.com